

USERS MANUAL



NexPump Instruction Manual

TABLE OF CONTENTS

Important Safety Precautions	1
Personal Precautions	2
NexPump Precautions	2
Installation Procedures	3
NexPump Display Status	6
System Operating Status	6
Mode Selection	6
Battery Operations	7
Auto Notification Status	7
Pump Operations	9
Charge Operations	11
Function Button	12
Alarm/Phone Monitor	12
Testing Operations	13
Stats Information	13
Internal Fan Status	14
Input Power	14
Sensor Operations	14
Auto Notification	16
Normal And Critical Errors	16
Appendix	17
Quick Reference	18
Label Code Chart	19
Warranty Information	20
Installation Examples	21

The *NexPump Advanced* is a microprocessor Controlled state-of-the-art sump pump system. Installed as a primary or backup sump pump it will protect your home or business with mission-critical reliability.

The NexPump Advanced System includes:

- 1 - *NexPump Advanced* System Unit
- 2 - 4000 GPH High Capacity Pumps w/Adapters
- 2 - Sensors with SS mounting clamps

Purchased Separately: (Required to operate)

- 1 - Deep-Cycle Rechargeable Battery
(See Appendix for more information)

You will also need to supply:

- 1-1/2" or 2" rigid PVC pipe and fittings
- PVC cement and primer
- Check valves

Please take a moment and review this manual before starting installation or powering up your NexPump Advanced System.

IMPORTANT SAFETY INSTRUCTIONS

SAVE THESE INSTRUCTIONS - This manual contains important safety and operating instructions for the *NexPump*. Follow these important safety precautions. Failure to follow safety precautions can result in personal injury or damage to the NexPump.

CAUTION - To reduce the risk of injury, charge only lead type rechargeable batteries. Other types of batteries may burst causing personal injury and damage.

Do not expose the NexPump System Unit to rain or snow.

Do not install the NexPump System Unit where temperatures will be below freezing (32 degrees Fahrenheit).

Do not charge a battery that may be frozen. Allow battery to sit at room temperature before connecting to the NexPump.

If an extension cord must be used, make sure

- A: That the pins on the plug or extension cord are the same number, size and shape as those of the plug on the NexPump System Unit.
- B: That the extension cord is properly wired and in good electrical condition.
- C: That the wire size is large enough for the AC ampere rating of the NexPump System Unit.

Do not operate the NexPump System Unit if it has received a sharp blow, been dropped, or otherwise damaged in anyway; take it to a qualified serviceman.

Do not operate the NexPump System Unit with a damaged cord or plug – have them replaced or repaired immediately.

Do not disassemble the NexPump System Unit; take it to a qualified serviceman when service or repair is required. Disassembly may result in a risk of electric shock or fire and void the warranty.

Never pull directly on any wiring connected to pumps, battery, AC power or sensor. Disconnect by pulling on connectors only.

Never force the connectors out of place, they should disconnect and connect easily. Some connectors have safety latches, so make sure they are depressed.

Never attempt any maintenance and/or cleaning with the NexPump powered up Risk of electric shock may result.

IF LEAD-ACID BATTERY IS USED

WARNING - RISK OF EXPLOSIVE GASES WORKING IN THE VICINITY OF A LEAD-ACID BATTERY CAN BE DANGEROUS. BATTERIES GENERATE EXPLOSIVE GASES DURING NORMAL BATTERY OPERATION. FOR THIS REASON, IT IS OF THE UTMOST IMPORTANCE THAT EACH TIME BEFORE USING YOUR NEXPUMP CONTROL UNIT YOU READ THIS MANUAL AND FOLLOW THE INSTRUCTIONS EXACTLY.

Be sure the area around the battery is well ventilated.

A SPARK NEAR THE BATTERY MAY CAUSE AN EXPLOSION.

PERSONAL PRECAUTIONS

IF LEAD-ACID BATTERY IS USED

Someone should be within range of your voice and/or close enough to come to your aid when you work near a lead-acid battery.

Have plenty of fresh water and soap nearby in case battery acid contacts skin, clothing or eyes.

Wear complete eye protection and clothing protection. Avoid touching your eyes while working near the battery.

If battery acid contacts skin and/or clothing, wash immediately with soap and water. If acid enters the eye, immediately flood eye with running cold water for at least 10 minutes and get medical attention immediately.

When the battery fluid level is low, add distilled water in each cell until the level reaches the indicator on each cell. *Do not overfill.*

PRECAUTIONS FOR ALL BATTERIES

NEVER smoke or allow a spark or flame in the vicinity of the battery.

Be extra cautious to reduce the risk of dropping a metal tool onto the battery. It might spark or short-circuit the battery or another electrical part that may cause an explosion.

Remove personal metal items such as rings, bracelets, necklaces and/or watches when working with a battery. A battery can produce a short-circuit current high enough to weld a ring (or the like) to metal, causing a severe burn.

When Cleaning the battery terminals. Be careful to keep corrosion from coming in contact with eyes.

Do not use the system unit for charging Dry-Cell batteries, that are most commonly used with household appliances. These batteries may burst and cause injury to persons and damage to property.

NEXPUMP PRECAUTIONS

NEXPUMP SYSTEM UNIT LOCATION

Locate the NexPump System Unit as far away from the battery as the DC cables permit.

Do not operate the NexPump System Unit in an area with restricted ventilation.

Do not set a battery on top of the NexPump System Unit.

Do Not allow the NexPump System Unit to sit on top of the battery.

Do not block NexPump System Unit ventilation in any way. Allow at least 6 inches of free space from the fan exhausts on the right side of the NexPump Unit.

Do not install the NexPump System Unit where temperatures will be below freezing (32 degrees Fahrenheit).

Do not install the NexPump System Unit where it will be exposed to outside elements.

DC CONNECTION PRECAUTIONS

The NexPump Unit requires a connected marine type deep-cycle battery for proper operation. You must assure the battery is connected while the NexPump Unit is operating.

When attaching the battery cables to the battery posts, secure them to insure a good connection.

The BLACK wire from the NexPump System Unit connects to the NEGATIVE (-) post of the battery. The RED wire from the NexPump System Unit connects to the POSITIVE (+) post of the battery.

The 'REVERSE POLARITY LED' will illuminate if the battery connections are reversed.



AC POWER REQUIREMENTS

The NexPump System Unit must be operated from 120 volt household current from the AC outlet.

GROUNDING AND AC CORD INSTRUCTIONS

The NexPump System Unit should be plugged into an outlet that is properly installed and grounded in accordance with all local codes and ordinances.

DANGER

Never alter the AC cord or plug provided – if it will not fit the outlet, have a proper outlet installed by a qualified electrician. Improper connection can result in a risk of an electric shock. An adapter ***should not*** be used with this NexPump System Unit.

Important Safe Guards:

Never allow other items that discharge into the sump pit to be unsecured. Unsecured items such as garden hoses, laundry hoses and other medium used to discharge water may interfere with the NexPump pumps or sensors. Be sure to secure all items that may be used to discharge water into the sump pit and verify that secured items will not interfere with any NexPump operations.

INSTALLATION PROCEDURES:

Installation of plumbing has many options depending on how the plumbing is setup in the first place. The most common method whether the NexPump is used as the primary(Diagram A) or a backup(Diagram B) is to wye the existing plumbing. If this is a new installation just one wye will be needed to create two discharge paths for each pump. Each pump can also have a separate discharge if this is preferable. However in most cases the use of tees or wyes will work fine. 2" PVC can be used to get the full dual pump discharge rate. The 2" only needs to be installed from the wye to the outside. Check valves must be installed when a common discharge is used. The check valves are designed to go one way, verify the correct direction when installing the check valve.

PARTS NEEDED FOR INSTALLATION:

Check Valves,PVC pipe, PVC cement and primer,Nylon Wire Ties

Install plumbing referring to the examples diagrams at that end of this users manual. The diagrams and the following assume 1-1/2" PVC pipe will be used. Arrange plumbing so when the vertical pieces are connected, the pumps will fit into the sump pit and each pump will sit on the bottom of the pit.

Note: For very narrow sump pits, pumps can be stacked on top of each other. Pump 1 must be the lowest pump.

Connect the wye to the discharge pipe. Connect the 45 degree elbow(s) to the wye. To attach check valves cement small pieces (approximately 2-1/2") of PCV pipe. This will allow enough PVC for the check valves to attach securely. Attach the check valves and securely tighten the hose clamps to the upper part of the PVC.

Note: Tighten all the hose clamps on check valves, not just the ones you are fitting.

Attach the Elbows to each Pump and tighten pump side clamp securely. Place and position each pump into sump pit.

Measure from the Elbow of each pump to corresponding check valve, add approximately 2-1/2" for insertion into check valve and elbow. Cut PVC to measured length. Drill a 1/8-inch vent hole approximately 3" from the end that will be inserted into the Elbow. Do this for each piece of PVC piece.

IMPORTANT: When using a check valve a small 1/8" hole must be drilled in the vertical discharge pipe of each pump. DO NOT DRILL INTO THE PUMP OR THE ELBOW. The hole should be drilled at a 45 degree downward angle to prevent water spraying upwards.

Trim as necessary so each pump will sit on the bottom of the pit as close to level as it can be.

Note: Again for very narrow sump pits, pumps can be stacked on top of each other. Pump 1 must be the lowest pump.

Note: Make sure the RED filter screen is securely attached to each pump.

Remove each pump and insert each vertical PVC piece into the Elbow, tighten hose clamps securely. Place each pump into pit again and insert PVC into the corresponding check valve. Tighten hose clamps securely.

IMPORTANT: REVIEW ALL SAFETY PRECAUTIONS AND INSTRUCTIONS BEFORE PROCEEDING!

Finishing Installation:

Step 1: POSITIONING THE SENSORS:

Sensor1 is the main sensor and will turn on the pump(s) when the water rises above the sensor. Sensor2 works like Sensor1 however, functions as a backup and high water alarm. Attach the sensors to any discharge pipe securely with the supplied stainless steel clamps (*float side down, sensor cable up, mounting bracket up, remove any shipping tape*). Float on each sensor should move freely up and down.

Position the sensors as described below.

Sensor1 (Bottom Sensor Receptacle):

NexPump in Backup Mode:

Position Sensor1 approximately 2-4 inches above the activation level of the Main pump. If not, the NexPump may show the pumps have been activated prematurely.

NexPump in Primary Mode (Only Sump Pump):

Position sensor1 approximately 2 inches above the pumps.

NexPump in Primary Mode (With Electric Sump Pump):

Position sensor1 above the level of the NexPump pumps and below the level that the AC pump will turn on.

Sensor2 (Top Sensor Receptacle):

Sensor2 is used as a backup and alert for high water. When activated the NexPump will begin operation in a special emergency mode and with 'Auto Notification' will alert immediately. Position sensor2 about 6 inches above all other trigger points.

IMPORTANT : If a vent hole is drilled in the discharge pipe make sure a sensor or sensor clamp does not block the vent hole. Do not position the sensor on the side of the discharge pipe facing the drain tile or any incoming rush of water. Be sure the sensor is positioned vertically with the mounting bracket at the top. Verify the sensor is not tilted in any way.

Step 2: SECURE WIRES:

Secure the pump and sensor wires to discharge pipes with nylon wire ties.

IMPORTANT : Make sure the wire ties or wires do not

interfere with the operation of the sensor.

Step 3: POSITION BATTERY AND NEXPUMP SYSTEM UNIT:

Place the battery in a battery box (if used) on the floor or on a secure shelf or ledge. Position the NexPump System Unit in a secure place ideally above the floor. Two 8" shelf brackets attached to the basement wall work fine to support the NexPump. The pump wires and sensor wires should be long enough to position the NexPump System Unit approximately 1-2 feet above the floor. Be sure the power cord will reach the AC power socket. Secure the electrical power cord as needed. **Do not plug in at this time.** Make sure battery cables will reach battery. **Do not connect battery cables at this time.**

Step 4: PUMP AND SENSOR CONNECTIONS:

Plug the pump connectors into the NexPump System Unit. **If both pumps are not on the bottom of the pit then Pump 1 must be the lowest pump.** Slightly pull back on each connector to verify they are securely attached. Plug in the Sensors. Primary Sensor (Sensor 1) to bottom receptacle. Backup Sensor (Sensor 2) to top receptacle. The sensor connectors plug in with the security latch to the right of the NexPump System Unit. Verify the sensor connectors are securely attached.

IMPORTANT:

To disconnect a pump connector, slightly depress the security latch on the bottom of the connector and pull out the connector.

To disconnect a sensor connector, slightly depress the security latch on the right side of the connector and pull out the connector.

Step 5: CONNECTING THE AC POWER CORD:

IMPORTANT: Make sure that the AC outlet is a grounded outlet.

If you have an electric pump you still want to operate, you should install a duplex receptacle (if you have a single outlet receptacle). This will allow an outlet for the NexPump Unit and your electric pump. A 20 amp receptacle should be used.

Note: Turn off the power to the outlet if replacing the receptacle is necessary.

Plug in the AC power cord and verify a secure connection. The NexPump Unit will turn on. The display will illuminate and 'Operating Status' LED should be blinking. The NexPump will display 'NexPump, Inc.'" and then the normal status mode.

Note: An Alarm may sound at this time because the battery is not connected.

Step 6: CONNECT THE BATTERY:

This side intentionally blank

Attach the battery cables to the battery, the BLACK wire to the NEGATIVE(-) post, the RED wire to the POSITIVE (+) post and tighten securely.

IMPORTANT: Check the 'Battery Reverse' LED on the NexPump System Unit and if it is illuminated the connections are reversed.

Step 7: CHECK YOUR NEXPUMP:

All alarms should be off at this time. Check the mode setting and set to your preferred setup (See Mode Selection - NexPump Operation). The NexPump will schedule an automatic self-test approximately two minutes after power up. If there are any errors they will be displayed on the LCD display and an alarm will sound.

Step 8: COVER AND SECURE BATTERY BOX:

If Battery Box was purchased, place Battery in Battery box, secure Battery Box cover with the safety strap.

Step 9: PERFORM A BATTERY RESET:

Check in Quick reference or Function Button section and perform a battery reset. This will enable the battery charge process.

Note: Always perform a battery reset when replacing a battery or installing a new system.

Your NexPump is ready for use!!



NEXPUMP DISPLAY STATUS:

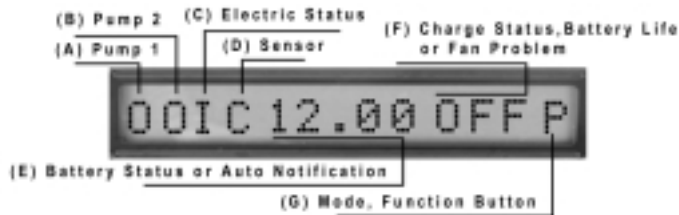

Note: The Emergency mode will automatically be selected if either Sensor is disconnected or BOTH pumps are in a disconnected mode. In the Emergency mode the pumps will operate every two minutes when the sensor is disconnected or operate both pumps when the pumps show a failed condition AND sensor 1 is active.

SYSTEM OPERATING STATUS:



The 'Normal Operation' LED must be blinking to indicate the NexPump Unit is operating. In addition, the mode location (last digit on display) will also be blinking with the mode the NexPump is in. If both of these are not blinking then there may be problem with the NexPump Unit.

MODE SELECTION:



Primary Mode - Used when pump is the primary pump

- o Mode switch in up position. The letter 'P' will be blinking in the mode position on display.
- o NexPump **WILL NOT** display or sound an alarm if pump(s) are activated.

Backup Mode - Used when pump is a backup pump

- o Mode switch in down position. The letter 'B' will be blinking in the mode position on display.
- o NexPump **WILL** display and sound an alarm if pump(s) are activated. Indicated by 'A' in the corresponding pump location.

Manual Mode – Used to manually turn on both pumps

- o Switch in up position manual mode is ON and in down position manual mode is OFF.
- o The letter 'M' will be blinking in the mode position on display.
- o When operating on battery power the NexPump will not calculate Battery Life Remaining.
- o Clog or Vapor Lock detection is disabled.
- o Pumps will turn off for 5 seconds each minute to clear possible Vapor Lock Conditions.
- o Auto Self-Test is disabled

Emergency Mode – Automatically selected

- o The letter 'E' will be blinking in the mode position on display.
- o Alarm will sound with display indicating the reason NexPump went into the Emergency mode.

BATTERY, AUTO NOTIFICATION STATUS:



The display digits 6-10 represent the Battery Status or indicates Auto Notification Status.

BATTERY STATUS:

'XX.XX' Battery voltage (Normal readings '12.40-13.20')

'Disc' Battery disconnected

Displays when Battery is disconnected or Battery voltage is below 1.5 volts

'Rep_' Check or Replace Battery

(The '_' indicates the reason for failure "numeric value")

- 1 = Battery failed due to load test
 - 2 = Battery failed due to charge cycling
 - 3 = Battery failed initial load test
- See (Battery Troubleshooting)

Auto Notification:

Notification will occur on Battery Disconnected or Battery Replacement Errors.

AUTO NOTIFICATION STATUS:

- "BUSY" - Notification System Lines Busy
- "INUSE" - Phone line is In Use
- "DIAL" - Dialing Notification System
- "CONND" - Connected to Notification System
- "INFOS" - Error Information sent
- "NLINE" - No Phone Line Connected
- "MFAIL" - Internal Notification System Problem

BATTERY TROUBLESHOOTING

If you are receiving a replace code on your NexPump display, do the following:

1. If you have Auto Notification, Disconnect the Phone Line
2. Disconnect the Battery, you DO NOT need to power off the NexPump System Unit.
3. Check fluid levels (See BATTERY FLUID LOW Section below)
4. If you DO NOT need to correct the fluid levels then you should replace the Battery, Follow the section on Battery Replacement
5. Re-Connect battery, Attach the battery cables to the battery - the BLACK wire to the NEGATIVE(-) post, the RED wire to the POSITIVE (+) post and tighten securely.

IMPORTANT: Check the 'Battery Reverse' LED on the NexPump System Unit and if it is illuminated the connections are reversed.

6. Perform a Battery Reset.
7. LCD will display 'Battery Reset'.

8. Charging cycle will begin.

9. If 'REP_' code sounds again soon after this procedure replace the Battery.

BATTERY MAINTENANCE:

Check Fluid levels, if applicable in Battery at least once every 6 months.

BATTERY REPLACEMENT:

IMPORTANT: Review the safety instructions before proceeding.

1. Disconnect the Battery.
2. Remove old Battery and dispose of properly.
3. Connect new Battery, Attach the battery cables to the battery - the BLACK wire to the NEGATIVE(-) post, the RED wire to the POSITIVE (+) post and tighten securely.

IMPORTANT: Check the 'Battery Reverse' LED on the NexPump System Unit and if it is illuminated the connections are reversed.

4. Perform a Battery Reset. *Function Button until 'R' displays* (
5. LCD will display 'Battery Reset'.
6. Charging cycle will begin.

BATTERY FLUID LOW: (LEAD-ACID BATTERY)

Follow the procedure below to refill the battery cells.

IMPORTANT: Follow the power off procedure and review the safety instructions before proceeding.

Remove the cell caps of battery. Add distilled water to each cell. If distilled water is not available tap water with a low mineral content may be used. *NEVER ADD MORE ACID.* Fill the battery cell so water is just below the fill cap.

BATTERY LIFE:

Battery life is approximately four years of the battery being in service. Most Deep-Cycle Batteries can endure hundreds of discharges and charges. The NexPump performs many tests to check the life of the battery and should alert you of potential battery problems.

CLEANING BATTERY TERMINALS:

Remove the battery cables and clean the battery posts with a battery post terminal cleaner or a wire brush. A 50/50 solution of water and baking soda may also be used if necessary. ***Do not*** allow the cleaning solution water to enter the battery. Thoroughly dry the posts and apply petroleum jelly or another terminal protective material if needed.

BATTERY CONNECTED IMPROPERLY:

This side intentionally blank

If the battery cables are connected to the wrong posts, the 'Reversed Polarity' Red LED will illuminate. If the NexPump unit is on when the reverse connection is made, an alarm will also sound and the input power will indicate as off as well as a FAN error.

Correct by reversing the battery cables.

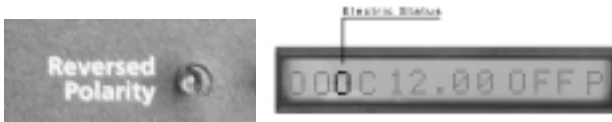

RUNNING ON BATTERY POWER:



A 'XXH' indicates the NexPump is on battery power. '99H' will be the maximum number displayed as shown above and does not reflect the actual battery life as this may be much greater. The number displayed is the **approximate time remaining** until the battery is discharged enough that the pumps will no longer function normally. The Battery Life Monitor calculates the remaining life approximately 4 times an hour. A close approximation should be displayed within the first 30 - 45 minutes. **When running on battery power you should closely monitor the Battery Life. Especially at 2 Hours left, at high duty cycle times the battery can quickly go to 0 Hours. This can take less than 1 hour, so be aware. While every attempt to accurately calculate the remaining battery life, fluctuating pump(s) times, battery condition and battery state before going to battery power will affect the calculated time throughout the power loss.** An alarm will also sound from the loss of electric power, which may silenced (See Silencing the Alarm). Once AC power is restored the display will again display the charge status. A charge cycle may also be enabled at this time.

IMPORTANT: When the Battery Life is calculated to be 2 Hours, an alarm will sound to let you know it is low on Battery Power. When the NexPump calculates there are zero hours left on the time remaining, the pump(s) will no longer operate. The pump(s) are disabled to prevent the battery from completely discharging and turning off the NexPump unit. When zero battery life is remaining the NexPump unit can still operate for hours to notify there are problems.

Auto Notification Module Installed:

Notification will occur on the initial loss of electric power. If you silence the alarm before the notification occurs, notification is canceled. When the calculated battery life is two hours, notification will occur with the impending battery life.

Note: If Battery Life is low and Battery Power is still needed you may connect a spare Battery at this time. If the NexPump is powered up with only the battery and is on battery power when the initial self test is scheduled, the self test WILL NOT run.

PUMP OPERATIONS:



DISPLAY IDENTIFIERS:

Pump 1 – First display digit

Pump 2 – Second display digit

Identifiers;

‘O’ Pump is off

‘I’ Pump is on

‘A’ or ‘a’ Pump was activated – Backup mode only *Note: If identifier is blinking, alarm is in the silence mode. To clear see Function button.*

‘F’ or ‘f’ Pump Problem

‘P’ or ‘p’ Possible Plumbing Clog error

‘V’ or ‘v’ Possible Vapor Lock

‘X’ or ‘x’ Suspected Clog Error

‘Y’ or ‘y’ Suspected Vapor Lock

‘R’ or ‘r’ Pump has over 2500 hours

‘Q’ Pump Driver Problem

To clear any error - See Function Button

PUMP DISPLAY IDENTIFIERS:

Each pump has a corresponding letter indicating the status of the pump. The lower case counterpart simply means the pump is currently in use. When the identifier is a ‘F’ or ‘f’ the NexPump has failed the indicated pump. However, if both pumps are considered failed the NexPump will attempt to operate the pumps within the Emergency Mode.

Auto Notification Module Installed:

Notification will occur on any pump problems.

PUMP TROUBLESHOOTING:

PUMP FAILURE:



Pump failures will sound an alarm and be indicated by the letter ‘F’ or ‘f’ in the corresponding location on the display. Other indicators can be ‘P’ or ‘p’ for a plumbing problem or ‘V’ or ‘v’ for a vapor lock problem. If both pumps are in the disconnected mode, the NexPump unit will enter the emergency mode to cycle the pumps every two minutes if Sensor1 is becomes active. Pump errors must be cleared by the function button. Plumbing and Vapor lock errors are cleared automatically. Clear the failed condition by depressing and holding the function button for 1 second, while the ‘C’ is in the last location of the

display release the function button. The display will show ‘Alarm Cleared’ and the identifiers will return to normal.

PUMP INDICATORS ON DISPLAY:

‘F’ or ‘f’ - Pump failure, followed by a corresponding ‘H’ or ‘L’ to indicate the failure type. If ‘H’ is indicated the pump is drawing too much current. If ‘L’ is indicated the pump is drawing to little current.

Troubleshooting ‘H’ :

Clear alarm and run self-test, if pump again shows failure with ‘H’ then pump is faulty

Troubleshooting ‘L’ :

Clear alarm and run self-test, if pump shows failure with ‘L’, check fuse condition for corresponding pump, check that connector is properly seated.

Important: Be very suspect if a pump shows failed. If subsequent tests reveal the same condition, the pump is faulty and SHOULD NOT be used. You can disconnect it from the NexPump Unit and disable the alarm until you can install a replacement pump. Do not use any other pump except an OEM pump from NexPump.

‘P’ or ‘p’ - Pump disconnected with plumbing clog. This error indicates a possible clog in the plumbing discharge. Verify the discharge is clear of obstructions. In the winter it may indicate a frozen discharge pipe. Error will clear automatically when sensor becomes inactive.

‘V’ or ‘v’ - Pump disconnected with vapor lock. This error indicates there may be air trapped in the discharge plumbing. It may also indicate the sensor is stuck in the up position. If a check valve is used, check for a proper vent hole in the pump discharge pipe or check if the vent hole is clogged. Error will clear automatically when sensor becomes inactive.

‘R’ or ‘r’ - Pump has reached it’s operational life-span. The pump may still be operational however has reached the average life span. The pump should be replaced as soon as possible. Contact NexPump for a replacement pump.

Note: Note which pump has the replace flag before clearing the alarm.

‘X’ or ‘x’ - ‘Suspect Mode’. When a clog condition is first detected the NexPump unit will display an ‘X’ in the corresponding pump location. This is just a precautionary mode to alert of a possible problem. The lower case ‘x’ indicates the pump is running.

‘Y’ or ‘y’ - ‘Suspect Mode’. When a vapor lock condition is first detected the NexPump unit will display a ‘Y’ in the corresponding pump location. This is just a precautionary mode to alert of a possible problem. The lower case ‘y’ indicates the pump is running.

‘Q’ - There may be an electronic circuitry problem. Call Support.

PUMP(S) ON:

This side intentionally blank

The display will show 'O' - off or 'I' - on. The pump(s) will turn off automatically when the water is below the pump discharge level.

Note: *When on battery power and the time remaining is near exhaustion, the pump(s) may continue to run for approximately 1 minute before turning off.*

PUMP WAS ACTIVATED: (Backup Mode Only)

If either pump was activated the display will show 'A' or 'a' for the corresponding pump. If the pump location is blinking the alarm is in the silence mode. An 'Activated Pump' alerts that the NexPump was needed. This may indicate the failure of the AC pump or other primary pump that the NexPump unit is backing up. It may also indicate that the incoming water was at a flow that the primary pump could not handle and the NexPump was needed for additional discharge capacity. After determining the source of the problem, clear the failed condition by depressing and holding the function button for 1 second, while the 'C' is in the last location of the display release the function button. The display will show 'Alarm Cleared' and return to normal.

PUMP REPLACEMENT

Displayed as 'R' or 'r'. Pump has reached average life span. Pump may still be operational however should be replaced at this time. Clear the condition by depressing and holding the function button for 1 second, while the 'C' is in the last location of the display release the function button. The display will show 'Alarm Cleared'.

Note: Write down which pump has been flagged as replace. Once cleared there is no user available method to retrieve the replace flag information.

PUMP FUSE

Each pump is protected by a 25-Amp ATC Type Fuse. The fuses are located inside the NexPump unit and can be accessed by the panel on the bottom. The power should be removed before attempting removal of the panel. The pump fuses are located towards the fan and are clear plastic with a 25 stamped on them. The Pump 2 fuse is closest to the access panel, while Pump 1 is directly above. If a fuse blows, check for possible obstructions or frayed wires on the failed pump. It may also indicate a failed pump.

CHARGE OPERATION:

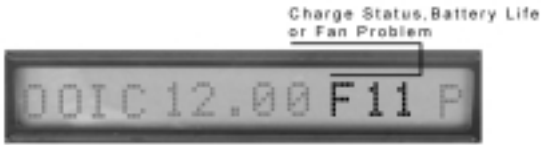

The display digits 12-14 represent the charge status, battery life remaining when operating on the battery or a Fan problem.

CHARGE STATUS

Note: The 'xx' indicates charge rate

'Off' Charge is **OFF**, battery is fully charged

'Fxx' Indicates the **Full** charge mode

'Txx' Indicates the **Trickle** charge mode.

'Mxx' Indicates the '**Maintain Mode**'

'Dis' Charge is disabled.

The charge disables for the following reasons:

Battery is disconnected, Input power is off, Both pumps are in use.

'ttS' The count in seconds when the charge system will start. This allows time for the battery to be reconnected before the charge starts again.

'FL1' or 'FL2' Charge system failed:

Verify battery and electric connections.

Check Charge Fuse and replace, if needed

Run manual test - if failed condition still exists unit may be defective.

CHARGING SYSTEM TROUBLESHOOTING:

CHARGING SYSTEM:

The NexPump has a built in automatic 20 amp battery charger. It is protected by a 25 amp Fuse inside the unit. The charging circuit is disabled anytime the battery or electric power is disconnected or if both pumps are operating. The charge states can be 'Off', 'Full', 'Trickle' and 'Maintain Mode'. When the charge is started the display will show 'Fxx', where the 'xx' is the actual charge rate in amps. The charge is automatically monitored at all times. After a full charge is complete the NexPump unit will go into a trickle charge mode. The display will show 'Txx' where the 'xx' is the charge rate. When the Trickle mode is complete, the NexPump will go into the '**Maintain Mode**'. In the 'Maintain Mode' charge rates can be very low and may even display 'M00' for extended times.

IMPORTANT: If you need to disconnect the battery or turn off the NexPump unit while charging is in progress, first remove the battery cables. This will disable the charging unit. After the charging system is disabled you can unplug the electrical power cord. The NexPump will remember what state the charge system was in and re-enable the charging state to the condition it was when the unit was turned off. After re-connecting the battery the NexPump will show a count down

from 30 seconds to allow you some time to re-connect the battery before the charge system starts again.

When the battery has reached its maximum charge the NexPump unit will automatically turn off the charging system. During automatic and manual tests the charge system is tested. The charge system is not tested while the electrical power is off or if the battery is disconnected. During these events the charge system is automatically disabled. If the charge system fails in any way the display will show 'FLx' in the charge status area and an alarm will sound.

CHARGER FAILURE:

In the event of a charge failure do the following:

1. Reset Charge Error
2. Verify battery and electrical connections.
3. Run a manual test to check the system again.
4. If Charge Fails again, Check Charge System Fuse (Replace as necessary)
5. *If charge system still indicates 'FLx' then the NexPump unit may be defective.*

Note: If the battery is completely discharged the NexPump may display the battery disconnected then count down from 5 seconds. This may cycle until the battery is at a sufficient level to start the full charge mode. This will prevent an overload to the charge system or battery.

CHARGING SYSTEM CIRCUIT BREAKER:

The charging system is protected by a 25 Amp ATC Type Fuse. The fuse is located inside the NexPump unit and can be accessed by the panel on the bottom. The power should be removed before attempting removal of the panel. The charger fuse is located in the middle of the circuit board and is clear plastic with a 25 stamped on it. If a fuse blows, check for possible shorting or frayed battery cables. Run a manual test to check the charge system again. If the charge system fails again the unit or battery may be defective.

Auto Notification Module Installed:

Notification will occur on a charger failure.

FUNCTION BUTTON:



When depressed and held, will allow user to perform a list of functions. The last display digit will read an alpha character and change about every 3 seconds. Release the function button when the display reads the function you would like to run.

The following is a list of functions:

'C' – Clears alarms

Clears alarms that must be manually reset. If there are no alarms currently active then NexPump will display that there are no alarms.

'S' or **'U'**– Silence or UnSilence Alarm

Useful if power is out and you do not want to hear the alarm for input power or pump(s) active. Automatically cleared after 24 Hours

'U' – Un-Silence alarm

Alarm will sound again

'T' – Will run manual self test.

(*See Automatic and Manual testing*)

'N' – Displays Serial Number.

'A' – Displays Firmware Revision and Option Code

'M' - Phone Monitor

'R' - Battery Reset.

'I' - Stats Information

'D' - Disable Alarm.

'E' - Re-Enable Alarm after being disabled.

SILENCING THE ALARM:

The alarm can be silenced for Normal Errors Only (*See Appendix*). Critical errors can be silenced by disabling the alarm as described below. To silence the alarm depress and hold the function button and wait (about 3 seconds) for the last digit on the display to change to **'S'** then release function button. The alarm is silenced for 24 hours and automatically enabled after that time.

Note: When the alarm is silenced the identifiers will blink to notify which conditions are in the alarm state.

UNSILENCING THE ALARM:

Repeat the above section on Silencing the alarm. Instead of a **'S'** displaying a **'U'** will display.

DISABLING THE ALARM:

The alarm can be disabled if needed. When disabled, the alarm will not sound, however the display will toggle **'ALDIS'** along with the battery voltage. To disable the alarm depress and hold the function button and wait (about 25 seconds) for the last digit on the display to change to **'D'** then release function button. The alarm is disabled for 5 days and automatically enabled after that time.

Note: All Notifications will take place while the alarm is disabled, disabling the alarm simply turns off the sound.

ENABLING THE ALARM:

Repeat the above section on Disabling the alarm. Instead of a **'D'** displaying a **'E'** will display.

PHONE MONITOR:

The Phone Monitor when enabled will alert you by sounding the alarm that the NexPump unit can no longer sense that a phone line is connected. The Phone Monitor is turned off by default. The display will toggle **'PHMON'** along with the battery voltage when this error occurs. To enable or disable the Phone Monitor, depress and hold the function button and wait (about 20 seconds) for the last digit on the display to change to **'M'**, then release function button. The display will appear as below.

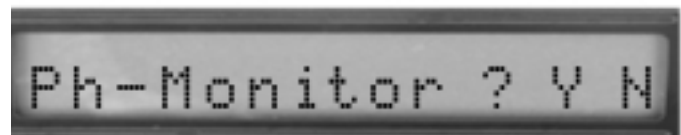

Press and hold the function button again, a blinking cursor will toggle between the **'Y'** and **'N'**. Release the function button and the system will save the current setting (about 10 seconds). This setting will remain in effect until changed, even if the unit is powered off. Clear the alarm using the function button **'C'** option.

Auto Notification Module Installed:

Once the alarm is silenced for a Normal Error, the Notification system will not provide Notification. However, if a Critical Error where to occur during the silence period Notification will occur. If the alarm is still active after the 24 hours silence period, the alarm again will sound and notification will occur.

BATTERY RESET:

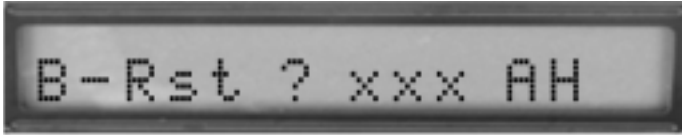

The Battery Reset is used to enable the charge system following a battery replacement, battery maintenance or new install. It is also used to change the amount of Amp Hours for your particular configuration. Depress and hold the function button for about 15 seconds, an 'R' will appear in the last character on the display, release the function button. The display should be as above, with the exception of the xxx will be a number between 105 and 320. Depress and hold the function button (number will increment by 5) until the number is the correct Amp Hour rating for your battery configuration. If you do not know use 105 for one battery and 210 for two batteries. Each time you perform a battery reset the NexPump system will default to the last configuration value. When the proper number is configured release the function button and the configuration will be saved (about 10 seconds after release). The charge system will then start.

STATS INFORMATION:

Depress and hold the function button for about 21 seconds, an 'I' will appear in the last character on the display, release the function button. The display will toggle through the following statistics:

1. P1=xxxxH (yy)
 xxxx = Pump 1 Count in Hours
 yy = Pump 1 2500 Hour Count
2. P2=xxxxH (yy)
 xxxx = Pump 2 Count in Hours
 yy = Pump 2 2500 Hour Count
3. CPU=xxxx Day(s)
 xxxx = Current Power Up Time in Days
4. TPU=xxxx Day(s)
 xxxx = Total Power Up Time in Days
5. ATC=xxxx
 xxxx = Automatic Test Count
6. PM=xxx BA=yyyA/H
 xxx = Phone Monitor Status (On, Off)
 yyy = Battery Amp/Hours

TESTING OPERATION:

The NexPump System can perform automatic and manual tests. An automatic test is scheduled every 12 Hours. A manual test can be performed any time NexPump unit is turned on (After initial power up test). To initiate a manual test depress and hold the function button and wait (about 6 seconds) for a 'T' in the last digit of the display, then release function button. A test is then scheduled to run.

Note 1: Some tests may be skipped because they cannot be tested at that time. For example; if the battery is being charged the NexPump will not test it until it is finished charging.

Note 2: On initial power up the NexPump will initiate an automatic test approximately two minutes after power up. There is no need to run a manual test after initial power up. However, if a manual test is scheduled on power up it will not run until after the automatic test is finished.

AUTOMATIC TEST:

Automatic testing of the NexPump is scheduled every 12 Hours. The following is a list of the tests performed during the automatic test:

Battery
Pumps
Charge System
Notification System (If Installed)
 Phone Line (If Phone Monitor is enabled)

MANUAL TEST:

Manual testing of the NexPump is available anytime (After initial power up test) with the function button. The following lists the components in the Manual test:

Battery
Pumps
Charge System
Notification System (If Installed)
 Phone Line Connection
 Phone Line Polarity
Alarm
Display

Note: At the end of any Manual or Automatic test the remaining water in the sump pit will be pumped out automatically. This will prevent water remaining in the sump pit and helps reduce corrosion of any metal pumps.

Auto Notification Module Installed:

Notification will occur with any problems detected after a test.

FAN PROBLEM:



'Fan' - Indicates a Case Fan Problem The 'Fan' indicator alternates (about 3 seconds) with the Charge Status or Battery Life.

Auto Notification Module Installed:

Notification will occur on a FAN Malfunctions.

INPUT POWER:



Identifier is third display digit
Identifiers

'O' Input power is off

'I' Input power is on

Note: If identifier is blinking, alarm is in the silence mode

INPUT POWER TROUBLESHOOTING:

POWER FAILURE:

During an electric power outage your Nexpump will automatically switch to battery power. The NexPump will display 'O' for the input power and sound an alarm. If the alarm is in the silence mode the display digit will be blinking. When power is restored the alarm will turn off automatically and an 'I' should be displayed for the input power.

POWER ON - INPUT SHOWS 'O':

If the power is on in the rest of the house :

1. Check your circuit breaker or fuse box for failure and correct as necessary.
2. Check the power plug. Make sure it is securely plugged into the wall socket.
3. Check a lamp or electric tester in the same outlet the NexPump is plugged into. If the outlet is working for another device then the power supply in the NexPump may be defective.
4. If power supply is suspected defective, the NexPump unit must be returned for repair.

IMPORTANT: The NexPump power supply is not field serviceable. Do not attempt to disassemble the NexPump or power supply.

POWER ON - INPUT SHOWS 'O' - INTERMEDIATELY:

1. Check if another appliance is plugged into the same outlet as the NexPump Unit. The appliance may be drawing too much power to run all the devices plugged into that outlet.
2. Unplug other appliances and check if problem is

resolved.

Auto Notification Module Installed:

Notification will occur on an electric power loss. If the alarm was silenced within 5 minutes of the alarm, the notification system will be postponed. If the alarm is still active after the silence period ends the alarm can be silenced again. This will also postpone the notification again.

SENSOR OPERATIONS:



Identifier is fourth display digit
Identifiers

'C' - Sensors are connected & operating normally

'1' - Sensor1 is disconnected

'2' - Sensor2 is disconnected

'H' - Sensor2 is activated (High Water Alert)

'D' - Both Sensors are disconnected

SENSOR TROUBLESHOOTING:

SENSOR DISPLAYING DISCONNECTED:

Verify the sensors are connected correctly and securely to the each sensor receptacle. If the sensors are connected correctly, the sensor may be defective.

Note: Anytime either sensor is disconnected the NexPump will enter the Emergency Mode, which will operate both pumps every 2 minutes. This is a safe guard mode since the NexPump cannot sense the water level if the sensor is malfunctioning or disconnected. If the backup sensor (sensor2) is activated the NexPump enters a Special Emergency Mode. Both pumps will run for 1 minute each 2 minutes if sensor2 remains active.

Auto Notification Module Installed:

Notification will occur on any sensor malfunctions. If the backup sensor (sensor2) becomes active the NexPump will provide immediate Notification since this is also considered a high water alert.

AUTO NOTIFICATION:

NOTE: AUTO NOTIFICATION IS AN OPTIONAL FEATURE:

INITIAL REGISTRATION:

You must register your NexPump before Notification use. Visit the NexPump's website 'www.nexpump.com' and click '**Register My NexPump**'. Fill in the registration form, the phone numbers and email addresses you want the Auto Notification system to use. The serial number should have the format 'NPAxxxxxxx'. Once registered you will receive an email confirming your setting.

CHANGING YOUR SETTING:

Visit the website at 'www.nexpump.com' and click '**Customer Login**'. Once logged in, you can change your information and update. You can also change your login password if you want. Once you updated your changes, you will receive an email confirming the changes.

NOTIFICATION DETAIL:

When the NexPump detects an error, activation or electrical failure it will sound an alarm. After approximately 30 minutes for Normal Errors and 5 Minutes for Critical Errors, if the alarm is still active, the Auto Notification feature will begin. Notification has two types, Normal and Critical. Normal and Critical errors are listed in the appendix. Notification of Normal errors can be silenced just like the alarm can be silenced. If you were notified by a Normal error such as a power failure, you may be notified again if a critical error were to occur. If you have been notified once for both a normal and critical error you will not be notified again until the alarm is cleared and an error reoccurs. If the alarm is automatically cleared, Notification will occur on each occurrence of the error. For example, the power fails. You are notified and acknowledge the call. The power is restored and fails again later in the day. You will be notified again of the power failure.

NOTIFICATION SETUP:

To enable Auto Notification you must have the Auto Notification Module installed. If you have the Auto Notification module simply plug in a standard phone cord into the phone jack on the left side of the NexPump System Unit. You should perform a manual test to verify the phone connection and polarity of the phone line.

1. Press Function Button Until '**T**' appears (6 seconds).
2. Release Function Button.
3. Test is scheduled.

The NexPump will test the ANMod, test the phone line connection and then test the polarity. A successful test will report the following:

Test ANMod - reports an error on failure only

Test PhLine - reports 'PhLine Connected'

Test Polarity - reports 'Polarity OK'

See Auto Notification Troubleshooting for problems

NOTIFICATION PROCESS:

Notification Call:

You answer the call:

1. States message(s),
2. Pressing 1 lets you skip any message.
3. Lets you confirm the message.
4. Press '1' to acknowledge or '0' to listen again.
 - a. Press '1' to acknowledge message.
5. Call ends
6. You will receive two emails, if configured.
 - a. Email stating the message.
 - b. Email confirming the status of the call.

Voicemail answers the call:

1. States the message(s).
2. Call ends
3. You will receive two emails, if configured.
 - a. Email stating the message.
 - b. Email confirming the status of the call.

NOTIFICATION CALL:

During a call you can press any digit to skip to the next message. Pressing '0' during the confirmation will replay the message. Once acknowledged the call process will end.

IMPORTANT NOTIFICATION DURING AN EVENT :

During an event we have found that many owners will continuously clear the error condition and receive notification calls over and over. Please review the information below.

1. Electric Failure, Pump Activation (Backup Mode)
 - a. To prevent notification from occurring over and over, you can **Silence the Alarm, Unplug the Phone Line**. If only the pump activation alarm is occurring, you can **Switch to the Primary Mode** for the duration of the event.
2. Sensor Alarms
 - a. If you are clearing Suspect or High Water Alarms multiple times is it best to **Unplug the Phone Line** for the duration of the event. Remember to plug the phone line back in after the event.

AUTO NOTIFICATION TROUBLESHOOTING:

TEST REPORTS 'NO PHLINE':

1. The phone line is not active. Check the phone line connection. You can verify the phone line with a standard phone and listen for a dial tone.

TEST REPORTS 'POLARITY REVRSED':

1. The phone line tip and ring wires are reversed. Simply reverse the tip and ring (typically the red and green wires) or proceed to step 2.
2. Check your phone extension cord.
 - a. The cord may be a cross over cable.
 - b. Replace with a straight through cable.

VERIFY AUTO NOTIFICATION IS INSTALLED:

1. Press Function Button Until 'A' appears (12 seconds).
2. Release Function Button.
3. Display shows revision number in the following format 'x.xx.xxxx 0000'. The 'x.xx.xxxx' is the revision number and the '0000' is any options installed.
4. If 'Auto Notification' is installed the option number will be '1xxx'. Only the first digit is applicable, if the number is a '0' then 'Auto Notification' is not installed.

NORMAL AND CRITICAL ERRORS:

NORMAL ERRORS:

Alarm be silenced - See Function Button Operation

Auto Notification System:

When alarm is silenced the Notification System is postponed. If the error continues when the 24 hour silence period expires, the alarm will sound and Auto Notification will occur.

Pump Activated – (Backup mode Only)

Cleared by Function Button.

(If you do not want the alarm to sound or worry about the Notification occurring after a silence period during a prolonged power outage. Simply switch the mode to primary. This will no longer sound the alarm or Notify on pump activation. Remember to switch the mode back to backup.)

Input Power Off

This error is automatically reset when power is restored

CRITICAL ERRORS:

Alarm be disabled - See Function Button Operation

Battery Disconnected

Automatically reset when battery is connected.

Sensor disconnected

Automatically reset when sensor is connected.

Pump Problem

Cleared by Function Button.

Fan

Automatically reset when Fan is operating correctly

Plumbing Errors

Automatically reset if condition corrects itself.

Suspect Mode

Automatically reset if condition corrects itself.

Charge System Problem

Cleared by Function Button

Battery Replacement

Cleared by Function Button

Two Hours or Less Battery Life Remaining

Reset when electric is restored and battery charges

Appendix:

This side intentionally blank

BATTERY SPECIFICATIONS:

Any marine type deep-cycle rechargeable battery can be used with your NexPump System.

A 105 Amp or greater capacity is recommended.

NOTE: MULTIPLE BATTERIES

Two batteries may be connected in **PARALLEL** to increase time on battery power.

DO NOT CONNECT THE BATTERIES IN SERIES AND CONNECT TO THE NEXPUMP. CONNECTING THE NEXPUMP TO 24-VOLTS WILL DAMAGE THE UNIT.

The NexPump Unit requires a connected marine type deep-cycle battery for proper operation. You must assure the battery is connected while the NexPump Unit is operating.

NEXPUMP SPECIFICATIONS:

Maximum Input/Output Levels:

Input: AC

120 Volts AC @ 7 amps

240 Volts AC @ 3.5 Amps

Input: DC - 12 VOLTS ONLY

12 Volts DC @ 28 amps

12 Volt Rechargeable Deep-Cycle Battery **ONLY**

Charge Output:

20 Amps DC

Protected by a 25 Amp ATC Type Fuse

Pump Inputs:

12 Amps @ 12V DC

Protected by a 25 Amp ATC Type Fuse

Operating Temperature:

0°C~50°C (32°F~122°F)

Storage Temperature:

-10°C~50°C (14°F~122°F)

Quick Reference Guide:

Power OFF:

1. Disconnect Battery
 - a. Disconnect (+) Positive Cable (Red)
 - b. Disconnect (-) Negative Cable (Black)
 - c. Verify Battery Reverse Indicator
2. Unplug NexPump's AC Power Cord

Power ON:

1. Plug in NexPumps AC Power Cord
2. Connect Battery
 - a. Connect (-) Negative Cable (Black)
 - b. Connect (+) Positive Cable (Red)
 - c. Verify Battery Reverse Indicator

Override Mode:

1. Set Override switch to up position
2. Both Pumps should turn on.
3. Battery Life will not be calculated
4. Clog or Vapor lock detection is disabled.
5. Pumps will turn off for 5 seconds every minute to clear possible Vapor Lock Conditions.
6. Set Override switch to down position to turn pumps off and return to normal.

Clear Alarm(s):

1. Press Function Button Until '**C**' appears (1 second).
2. Release Function Button.
3. Display shows 'Alarm Cleared' if there are any that can be cleared, otherwise displays 'No CLR Alarms'.

Silence Alarm:

1. Press Function Button Until '**S**' appears (3 seconds).
2. Release Function Button.
3. Display shows 'Alarm Silenced'

Note: Will be silent for 24 hours and re-enable itself automatically

UnSilence Alarm:

1. Press Function Button Until '**U**' appears (3 seconds). (A '**U**' will only appear if the alarm is silenced already)
2. Release Function Button.
3. Display shows 'Alarm UnSilenced'

Manual Test:

1. Press Function Button Until '**T**' appears (6 seconds).
2. Release Function Button.
3. Test is scheduled.

Get Serial Number:

1. The NexPumps serial number is located on the rear unit or proceed to step 2.
2. Press Function Button Until '**N**' appears (9 seconds).
3. Release Function Button.
4. Display shows SN-NPAXxxxxxxx where 'xxxxxxx' is the serial number

Get Firmware Revision:

1. Press Function Button Until '**A**' appears (12 seconds).
2. Release Function Button.
3. Display shows revision number in the following format 'x.xx.xxxx 0000'. The 'x.xx.xxxx' is the revision number and the '0000' is any options installed.

Phone Monitor:

1. Press Function Button Until '**M**' appears (24 seconds).
2. Display shows 'Ph-Monitor ? Y N'.
3. Depress and hold Function Button, display will toggle between 'Y' and 'N', release when at correct setting.

Battery Reset:

1. Press Function Button Until '**R**' appears (18 seconds).
2. Release Function Button.
3. Display shows 'B-Rst ? xxx AH'.
4. Enter Battery Amp Hours
5. Battery Charge will start.

Stats Information:

1. Press Function Button Until '**I**' appears (21 seconds).
2. Release Function Button.
3. Display will toggle through NexPump statistics.

Disable Alarm:

1. Press Function Button Until '**D**' appears (27 seconds).
2. Display shows 'Alarm Disabled'.
3. Alarm remains disabled for 5 days then automatically re-enabled

Enable Alarm:

1. Press Function Button Until '**E**' appears (27 seconds).
2. Display shows 'Alarm Enabled'.

NexPump Code Chart

A - Pump 1, B - Pump 2 - (Page 9)

- 'O' Pump is Off
- 'I' Pump is On
- 'A' or 'a' Pump was activated – Backup mode only
- 'F' or 'f' Pump Problem
- 'P' or 'p' Possible Plumbing Clog error
- 'V' or 'v' Possible Vapor Lock
- 'X' or 'x' Suspected Clog Error
- 'Y' or 'y' Suspected Vapor Lock
- 'R' or 'r' Pump has over 2500 hours

C - AC Input - (Page 14)

- 'O' Input power is off,
- 'I' Input power is on

D - Sensors - (Page 14)

- 'C' - Sensors are connected & operating normally
- '1' - Sensor1 is disconnected
- '2' - Sensor2 is disconnected
- 'H' - Sensor2 is activated (High Water Alert)
- 'D' - Both Sensors are disconnected

E- Battery Status - (Page 7)

- 'XX.XX' Battery voltage in Volts
Normal Voltage Readings '12.40-13.20'
- 'Disc' Battery disconnected
Displays when Battery is disconnected or
Battery voltage is below 1.5 volts
- 'Rep_' Check or Replace Battery

E - Auto Notification - (Page 7, 15)

- "BUSY" - Notification System Lines Busy
- "INUSE" - Phone line is In Use
- "DIAL" - Dialing Notification System
- "CONND" - Connected to Notification System
- "INFOS" - Error Information sent
- "NLINE" - No Phone Line Connected
- "MFAIL" - Internal Notification System Problem

F - Charge Status - (Page 11)

- Off** Charge is off, battery is fully charged
- 'Fxx' Indicates the Full charge mode
- 'Txx' Indicates the Trickle charge mode.
- 'Mxx' Indicates the Maintain Mode
- 'Dis' Charge is disabled.
- 'ttS' The count in seconds when the charge system will start. This allows time for the battery to be reconnected before the charge starts again.
- 'Fld' Charge system failed

F - Battery Life - (Page 8)

The number displayed is the **approximate time remaining** until the battery is discharged enough that the pumps will no longer function normally.

F - Fan Problem - (Page 14)

'Fan' - Indicates a Case Fan Problem.

G - Mode - (Page 6)

- 'P' - Primary Mode
- 'B' - Backup Mode
- 'M' - Manual Mode
- 'E' - Emergency Mode

G - Function Button - (Page 12)

- 'C' - Clears alarms
- 'S' or 'U' - Silence or UnSilence Alarm (24 Hours)
- 'T' - Run manual self test
- 'N' - Displays Serial Number
- 'A' - Displays Firmware Revision and Option Code
- 'M' - Phone Monitor
- 'R' - Battery Reset
- 'I' - Stats Info
- 'D' or 'E' - Disable or Enable Alarm (5 days)

H - Pump Mode - (Page 6)

- Primary** - Switch in UP position
Mode on LCD blinking 'P'
- Backup** - Switch in DOWN position
Mode on LCD blinking 'B'

J - Override - (Page 6, 18)

- On** - Switch in UP position
Both Pumps On
- Off** - Switch in DOWN position
Both Pumps Off and in Normal operating mode

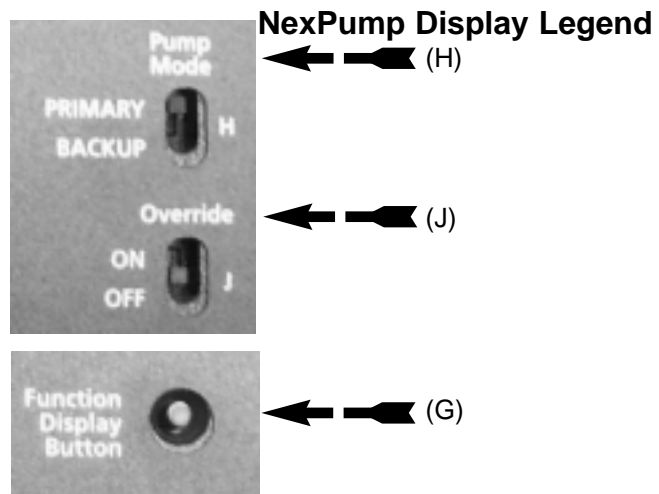
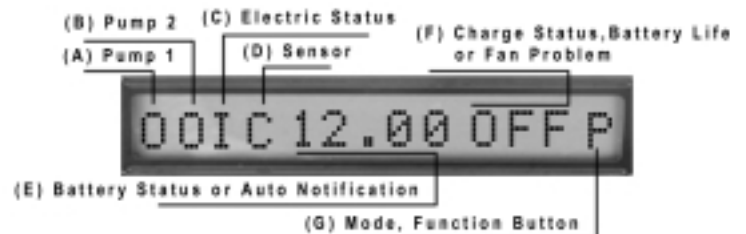

LIMITED WARRANTY

This NexPump, Inc. product is warranted against defects in workmanship and materials. If any failure of these components, resulting from a defect in either workmanship or material shall occur under normal use within THREE YEARS from the original date of purchase, such failure shall be corrected free of charge to the original purchaser by repair or, at NexPump's sole option, replacement of the defective part or parts.

No charge shall be made for labor or services performed during the said warranty period providing the defective product is sent prepaid to our Authorized Service Station. NexPump, Inc. will either repair or at its sole option, replace any such part except for fuses, circuit breakers under normal and proper use. This warranty does not cover pumps that have exceeded 2500 hours of operating time and does not cover equipment, which had been tampered with in any way, or to damage caused by accident, negligence, alteration, misapplication or acts of GOD.

This product must be returned transportation prepaid, properly packed and insured. NexPump, Inc. bears transportation cost of the repaired product back to the purchaser. This warranty applied only to the original purchaser.

NO OTHER WARRANTIES ARE EXPRESSED OR IMPLIED. NEXPUMP, INC. IS NOT LIABLE FOR CONSEQUENTIAL DAMAGES.

EXCEPT AS SET FORTH HEREIN, THERE ARE NO WARRANTIES, EXPRESS OR IMPLIED, WITH RESPECT TO NEXPUMP PRODUCTS. NEXPUMP, INC. EXPRESSLY EXCLUDES AND DISCLAIMS ANY IMPLIED WARRANTY OF MERCHANTABILITY AND ANY WARRANTIES OF FITNESS FOR A PARTICULAR PURPOSE, APPLICATION OR USE. UNDER NO CIRCUMSTANCES WILL THE COMPANY BE LIABLE FOR SPECIAL, INCIDENTAL OR CONSEQUENTIAL DAMAGES, WHETHER SUCH DAMAGES ARE SOUGHT IN CONTRACT, IN TORT (INCLUDING BUT NOT LIMITED TO NEGLIGENCE AND STRICT LIABILITY) OR OTHERWISE, AND THE COMPANY'S LIABILITY SHALL IN NO EVENT EXCEED THE PURCHASE PRICE OF THE NEXPUMP PRODUCTS ON WHICH SUCH LIABILITY IS BASED.

IMPLIED WARRANTIES, INCLUDING ANY WARRANTY OF MERCHANTABILITY IMPOSED ON THE SALE OF THIS PRODUCT UNDER STATE LAW, ARE LIMITED TO THREE YEARS DURATION FOR THE PRODUCT OR ANY OF ITS PARTS. SOME STATES DO NOT ALLOW LIMITATIONS ON HOW LONG AN IMPLIED WARRANTY LASTS OR UPON CONSEQUENTIAL DAMAGES, SO THE ABOVE LIMITATION MAY NOT APPLY TO YOU.

Diagram A
NexPump Installed as only pump
(NexPump operating in Primary Mode)

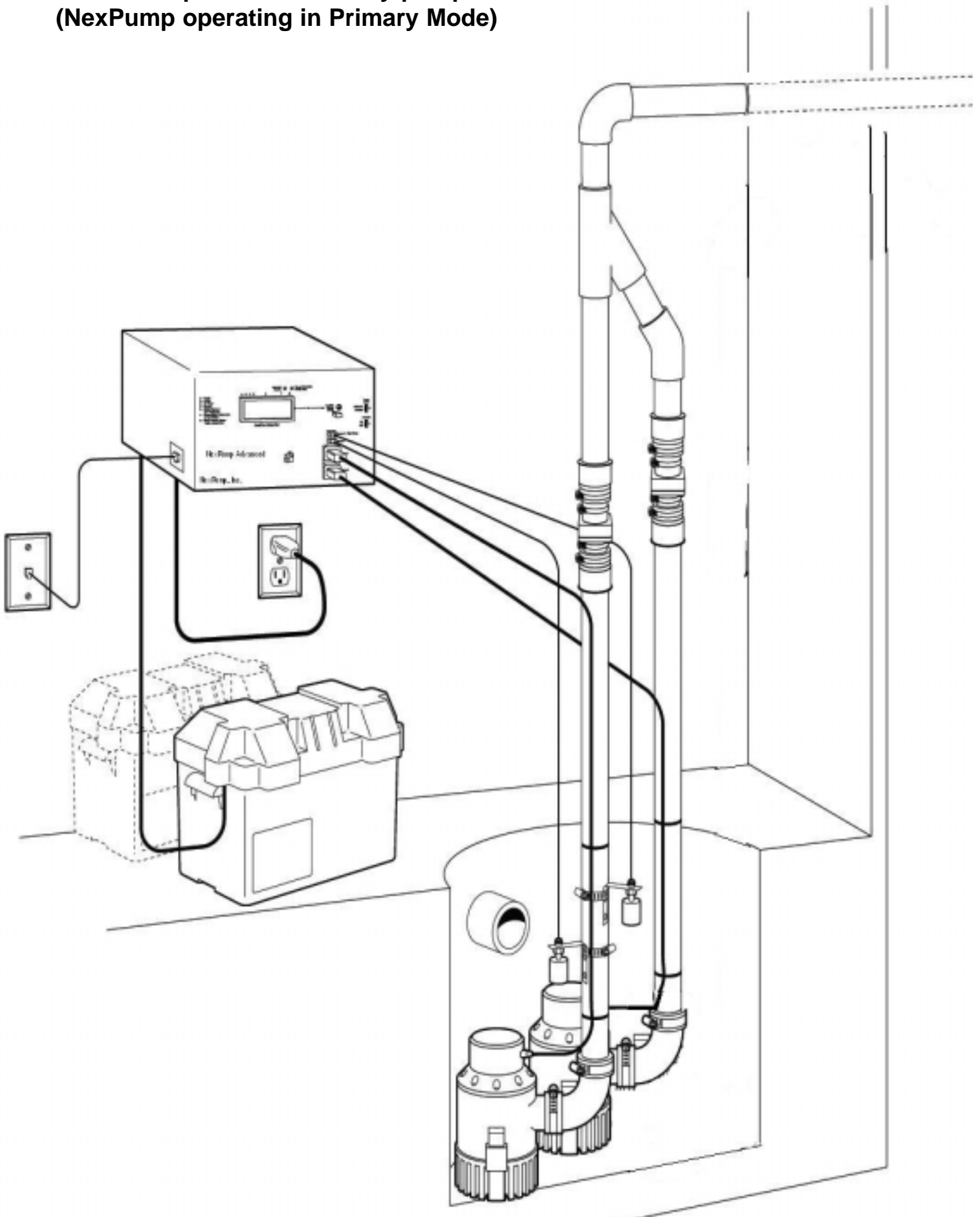

Diagram B
NexPump Installed with existing pump
(NexPump operating in Primary or Backup Mode)

